

STOKVIS

ENERGY SYSTEMS

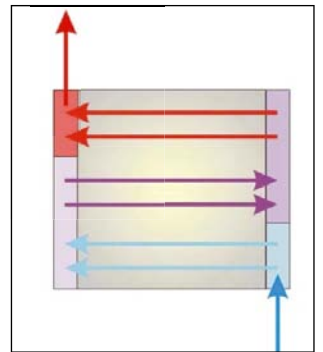
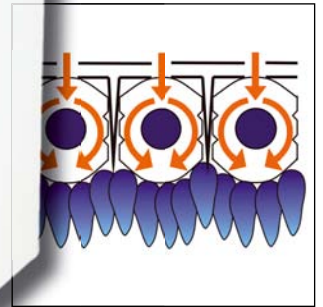
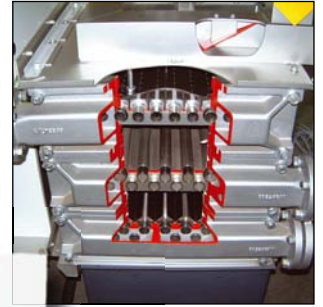

ECONOFLAME
PREMIX COMMERCIAL BOILERS
R3400 R3500 R3600SB

STANDARD FEATURES AND BENEFITS:

Since 1985 Stokvis have been offering a range of fully modulating, high efficiency, gas fired boilers. Researched and developed over the years, evolving throughout, has culminated in a most comprehensive range - some 23 models - of "state of the art", fully modulating, high efficiency, condensing, ultra low NOx, pre-mix gas fired boilers.

Fully Modulating pre mix burner:

A speed controlled fan blows air into the boiler – the air is then thoroughly mixed with gas before being fed to the burner. A temperature controller compares the desired water temperature with the actual temperature of the water flow – a feedback signal is sent to the frequency converter on the fan – thus ensuring the correct heating capacity is provided by adjusting the speed of the fan - thereby providing smooth step less modulation between 25% and 100% of the boiler capacity.

High efficiencies achieved:

A direct effect of the 100% premix process and the step less matching of the boiler capacity to system requirements is that very high efficiencies are achieved. Optimum efficiencies of 106.5% net are achieved.

Ultra low NOx emissions:

Throughout the full range of the Econoflame boilers, flue emissions are kept very low:-

NOx - R3400	22 - 61.4mg/kWh
R3500	11.5 - 19.5mg/kWh
R3600SB	11.5 -19.5mg/kWh
CO - R3400	9.8mg/kWh
R3500	27.3mg/kWh
R3600SB	27.3mg/kWh

The full range of Econoflame boilers are Building Regulations 'Part L' England , 'Part J' Scotland, compliant.

High build quality:

Since 1985 the Econoflame boilers have been renowned for their build quality and longevity of performance. Due to advances in materials available and technological developments over the years, the new Econoflame range of boilers have an even higher build quality – the pre mix burners are tubular stainless steel – and the heat exchangers – either two or three per boiler depending on the range – are also stainless steel. Components come with a twelve month guarantee against manufacturing or material defects.

Another very important advancement is that the whole range of boilers are constructed from recyclable materials – further savings of our planets resources.

Flexible controls packages:

Standard Boiler Control :

The principal employed by the standard boiler control is as follows:

The boiler begins operating on receipt of a heating demand. This heating demand is generated either by –

- A If the measured supply temperature is lower than the desired temperature.
- B As a result of ' service operation' mode having been selected.
- C in 'standby' mode when the water temperature falls below the frost protection temperature.

After the boiler has started up, the PID controller sends a signal to the fan, thus controlling the fan speed. Depending on the quantity of air displaced by the fan, the proportional pressure regulator will add the corresponding quantity of gas. In this way the boiler power is continuously modulated, enabling the boiler to accurately follow the demand for heat. The fan is equipped with a speed feedback, enabling an even more accurate control behaviour.

Once the supply water temperature exceeds the desired value, the boiler will shut down. As soon as the supply water temperature falls below the set value, the boiler re-starts.

The standard boiler control offers the following safety components:-

- Flame protection (1 x re-start)
- Water flow protection
- Maximum water temperature protection
- Gas valve test
- Overload and under-load protection



In addition, the boiler control system can be extended by fitting one of the following three options :

- BM8 option :** This is a weather – compensated controller with the following possibilities
 - Three on/off periods per day with three different temperatures.
 - Night time temperature reduction
 - Domestic hot water priority with time programming
 - Anti-legionella provision.
 - Optimum start.
 - Room – temperature sensor (can be switched off)
 - Two – wire communication bus connection
 - Multi language display
 - External control

E8 option : This is a controller by which two secondary circuits can be weather – dependently controlled. In addition the domestic hot water temperature can be independently

controlled. All of the settings can be adjusted independently for each of the circuits . This E8 controller can be further extended by use of the BM8 option for each circuit. The boiler is then directly weather compensated.

KKM8 option : This is a boiler cascade manager allowing up to eight boilers to be switched in cascade The KKM option offers the same functions as the E8 option.

As well as offering a very flexible controls package, Stokvis also has in it's product portfolio an extensive range of ancillary equipment such as pressure sets, cold water booster sets, buffer vessels and low velocity headers. (see www.stokvisboilers.com or contact Stokvis directly tel. 0208 783 3050 for a CD)

All in all it makes Stokvis Energy Systems a one stop shop for most if not all of your '21st century boiler house' needs.

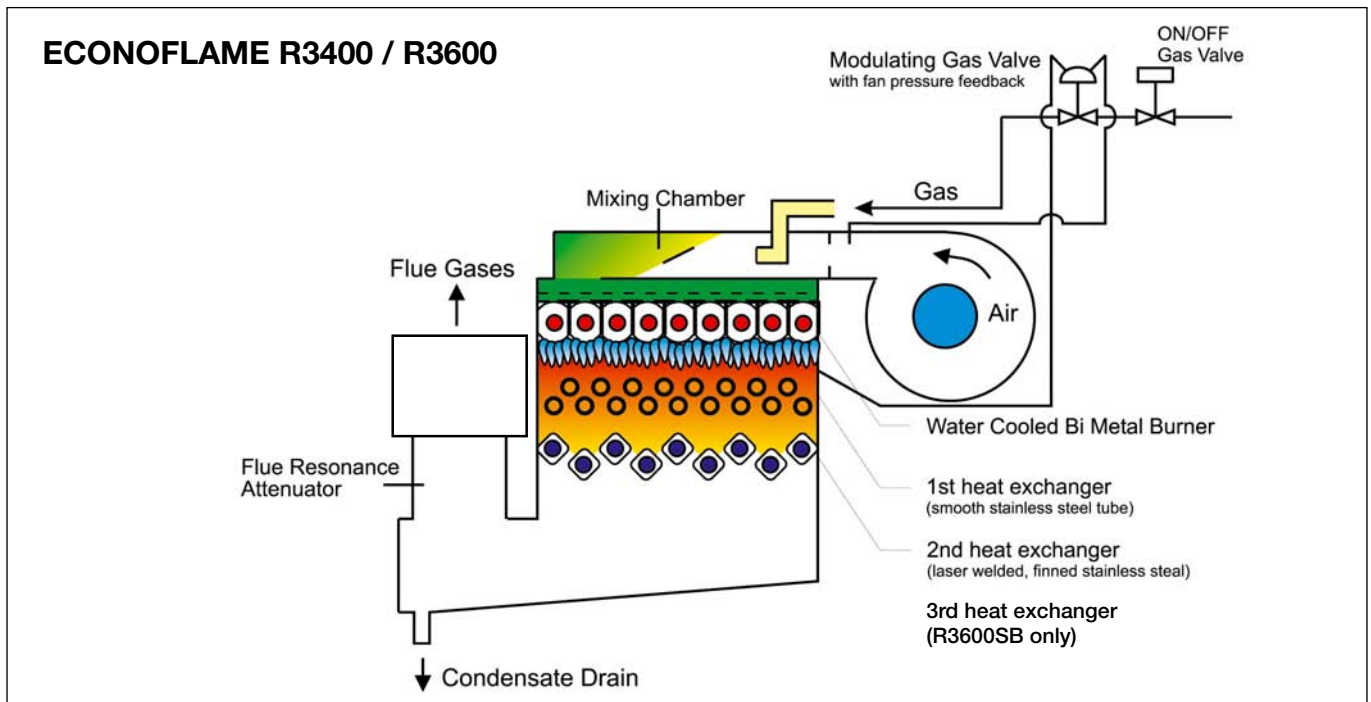

Efficiency Figures

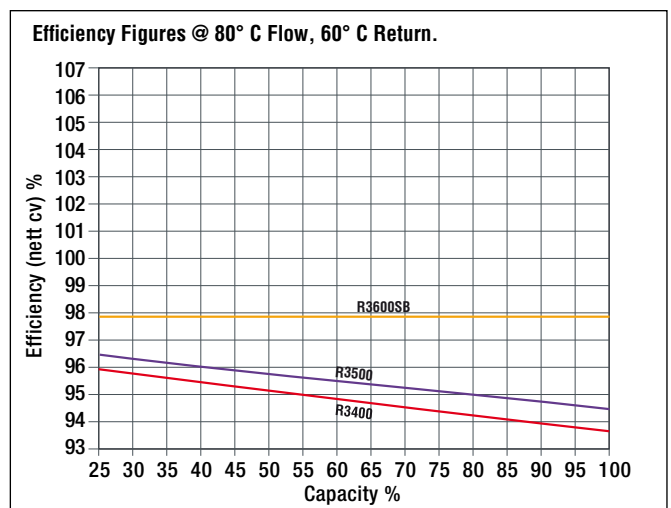
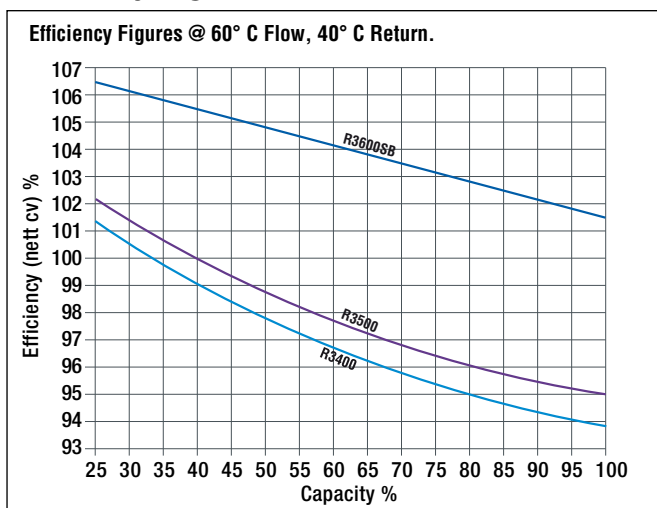

ECONOFLAME BOILERS

R3400

R3500

R3600SB



ECONOFLAME BOILER RANGE TECHNICAL DATA

Type	R3400							R3500						R3600SB					
		R3401	R3402	R3403	R3404	R3405	R3406		R3501	R3502	R3503	R3504	R3505		R3601SB	R3602SB	R3603SB	R3604SB	R3605SB
Nominal heat output	kW	657	729	853	965	1078	1189	kW	613	717	811	906	1000	kW	639	747	846	945	1043
Nominal heat input (nett. CV)	kW	702	784	917	1038	1159	1279	kW	653	764	865	966	1066	kW	653	764	865	966	1066
Minimum heat output	kW	176	196	229	260	290	320	kW	187	218	247	276	305	kW	187	218	247	276	305
Pilot Burner	kW	36	36	36	36	36	36	kW	30	30	30	30	30	kW	30	30	30	30	30
Gas consumption																			
natural gas H (10,9 kWh/m ³)	m ³ /h	64.5	71.9	84.1	95.2	106.3	117.3	m ³ /h	59.9	70.1	79.4	88.6	97.8	m ³ /h	59.9	70.1	79.4	88.6	97.8
Propane (12,8 kWh/kg)	kg/h	54.9	61.2	71.6	81.1	90.5	99.9	kg/h	51.0	59.7	67.6	75.5	83.3	kg/h	51.0	59.7	67.6	75.5	83.3
Gas inlet pressure																			
natural gas (min - max)	mbar	18-25	18-25	35-100	35-100	35-100	35-100	mbar	18-25	18-25	18-25	18-25	18-25	mbar	18-25	18-25	18-25	18-25	18-25
natural gas (max) option	mbar	100	100	-	-	-	-	mbar	100	100	100	100	100	mbar	100	100	100	100	100
Propane (min - max)	mbar	30-50	30-50	30-50	30-50	30-50	30-50	mbar	30-50	30-50	30-50	30-50	30-50	mbar	30-50	30-50	30-50	30-50	30-50
Water capacity	dm ³	50	53	70	75	80	85	dm ³	53	70	75	80	85	dm ³	73	97	104	110	117
Max. working pressure	bar	6	6	6	6	6	6	bar	6	6	6	6	6	bar	6	6	6	6	6
Gas connection		Rp2"	Rp2"	Rp2"	Rp2"	DN65 PN16	DN65 PN16		Rp2"	Rp2"	Rp2"	DN65 PN16	DN65 PN16		Rp2"	Rp2"	Rp2"	DN65 PN16	DN65 PN16
Water connections		DN65 PN6	DN65 PN6	DN80 PN6	DN80 PN6	DN80 PN6	DN80 PN6		DN65 PN6	DN80 PN6	DN80 PN6	DN80 PN6	DN80 PN6		DN65 PN6	DN80 PN6	DN80 PN6	DN80 PN6	DN80 PN6
Flue connection	mm	300	350	350	400	400	400	mm	300	350	350	400	400	mm	300	350	350	400	400
Air Supply Connection (option)	mm	250	300	300	355	355	355	mm	250	300	300	355	355	mm	250	300	300	355	355
Safety Valve connection		1 1/4"	1 1/4"	1 1/2"	1 1/2"	1 1/2"	2"		1 1/4"	1 1/4"	1 1/2"	1 1/2"	1 1/2"		1 1/4"	1 1/4"	1 1/2"	1 1/2"	1 1/2"
relief connection		1 1/2"	1 1/2"	2"	2"	2"	2 1/2"		1 1/2"	1 1/2"	2"	2"	2"		1 1/2"	1 1/2"	2"	2"	2"
standard setting	bar	3	3	3	3	3	3	bar	3	3	3	3	3		3	3	3	3	3
Power supply	V	400 3N-	400 3N-	400 3N-	400 3N-	400 3N-	400 3N-	V	400 3N-	400 3N-	400 3N-	400 3N-	400 3N-	V	400 3N-	400 3N-	400 3N-	400 3N-	400 3N-
Frequency	Hz	50	50	50	50	50	50	Hz	50	50	50	50	50	Hz	50	50	50	50	50
Fuse	A	16	16	20	20	20	20	A	16	16	20	20	20	A	16	16	20	20	20
Max. electrical power consumption																			
unit	kW	0.90	0.90	1.27	1.27	1.27	1.27	kW	0.90	0.90	1.27	1.27	1.27	kW	0.90	0.90	1.27	1.27	1.27
pump maximum	kW	1.15	1.15	1.15	1.50	1.50	1.50	kW	1.15	1.15	1.15	1.50	1.50	kW	1.15	1.15	1.15	1.50	1.50
total	kW	2.05	2.05	2.42	2.77	2.77	2.77	kW	2.05	2.05	2.42	2.77	2.77	kW	2.05	2.05	2.42	2.77	2.77
Weight, empty, ± 5 %	kg	675	740	840	950	1070	1200	kg	740	840	950	1070	1200	kg	890	1040	1150	1280	1410
Table Technical Data																			
- Heat output measured with :	60 - 80 °C							60 - 80 °C						60 - 80 °C					
- Gas consumption at	1013 mbar. 15 °C, dry							1013 mbar. 15 °C, dry						1013 mbar. 15 °C, dry					
- Gas specification	II _{2H3P}							II _{2H3P}						II _{2H3P}					
- Appliance category	B23, C53, C33 or C63							B23, C53, C33 or C63						B23, C53, C33 or C63					
- Protection degree	IP20							IP20						IP20					

Dimensions R3400 / R3500

front view

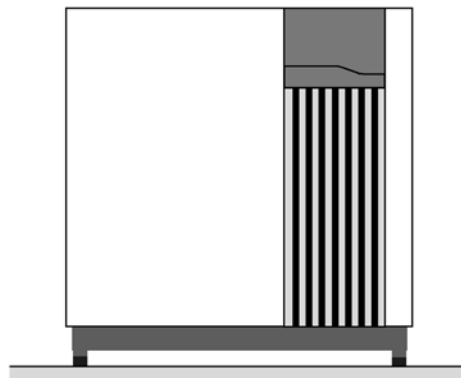

plan view

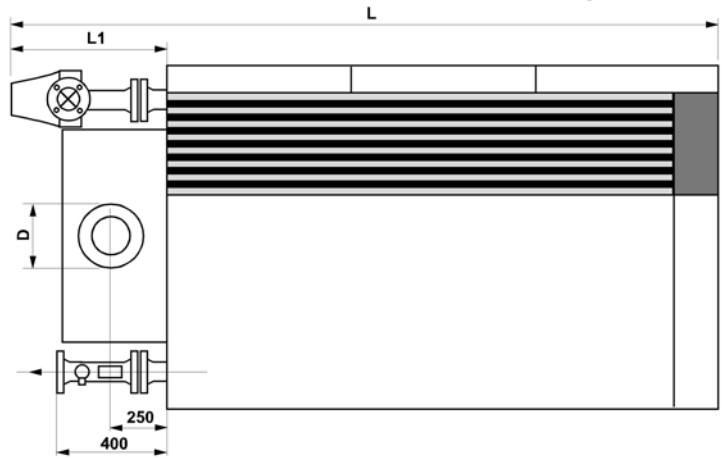

rear view

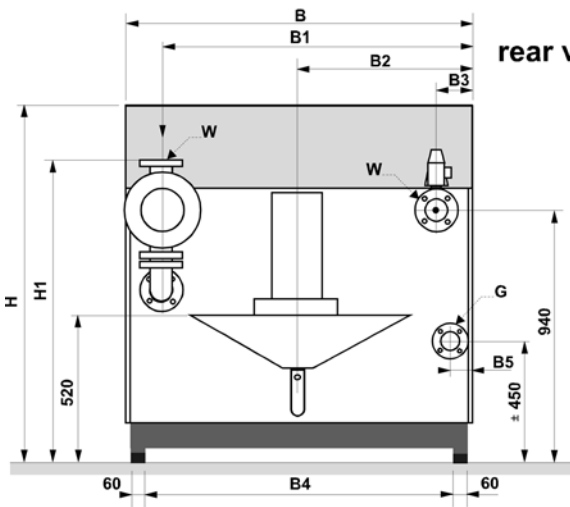

side view

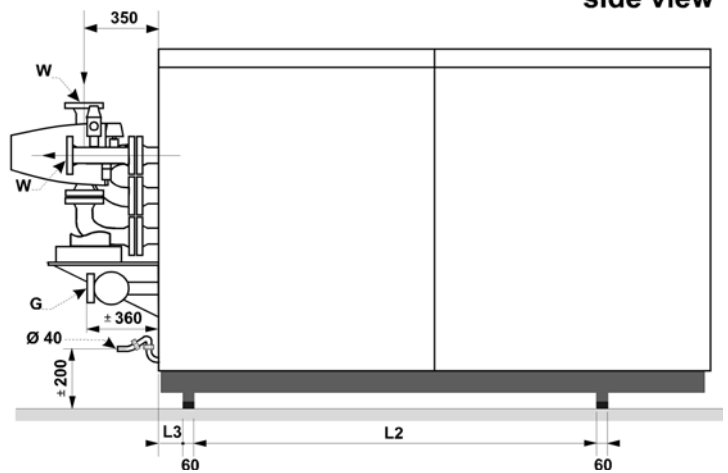

Type	R3401	R3501	R3402	R3502	R3403	R3503	R3404	R3504	R3405	R3505	R3406
B	mm	1330	1330	1130	1130	1130	1130	1330	1330	1330	1330
B1	mm	1160	1210	1210	1003	1053	1053	1203	1203	1253	1253
B2	mm	665	665	665	565	565	565	665	665	665	665
B3	mm	170	120	120	127	77	77	127	127	77	77
B4	mm	1146	1146	1146	946	946	946	1146	1146	1146	1146
B5	mm	115	65	65	115	65	65	115	115	65	65
D	mm	300	350	350	350	350	400	400	400	400	400
G		Rp2"	Rp2"	Rp2"	Rp2"	Rp2"	Rp2" DN65PN16	DN65PN16	DN65PN16	DN65PN16	DN65PN16
H	mm	1355	1355	1355	1355	1355	1355	1355	1355	1355	1355
H1	mm	1125	1125	1125	1400	1400	1420	1155	1155	1155	1377
L	mm	2265	2265	2265	2653	2653	2653	2658	2658	2658	2658
L1	mm	595	595	595	610	610	615	615	615	615	770
L2	mm	700	700	700	1166	1166	1166	1166	1166	1166	1166
L3	mm	108	108	108	88	88	88	88	88	88	88
W		DN65 PN6	DN65PN6 DN80PN6	DN80PN6	DN80PN6	DN80PN6	DN80PN6	DN80PN6	DN80PN6	DN80PN6	DN80PN6

As a result of manufacturing tolerances, there may be small variations in the dimensions. (Changes may be introduced without notice)

Dimensions R3600SB

front view

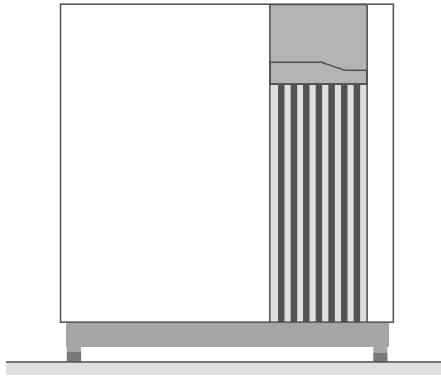

plan view

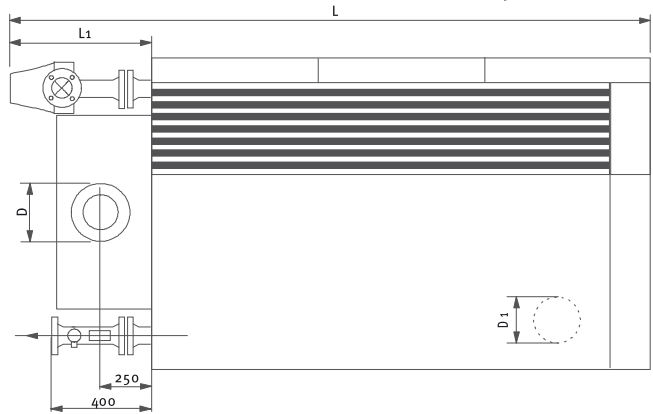

rear view

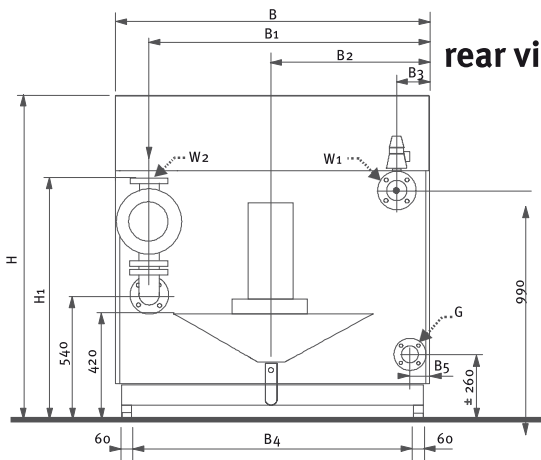

side view

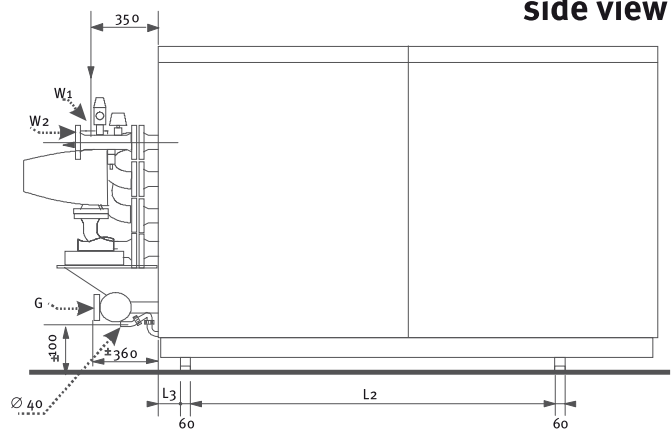

Type		R3601SB	R3602SB	R3603SB	R3604SB	R3605SB
B	mm	1330	1130	1130	1330	1330
B1	mm	1210	1003	1053	1203	1253
B2	mm	665	565	565	665	665
B3	mm	120	127	77	127	77
B4	mm	1146	946	946	1146	1146
B5	mm	65	115	65	115	65
D	mm	300	350	350	400	400
D1	mm	250	300	300	355	355
G		Rp2"	Rp2"	Rp2"	DN65 PN16	DN65 PN16
H	mm	1405	1405	1405	1405	1405
H1	mm	1175	1450	1450	1205	1427
L	mm	2265	2653	2653	2658	2658
L1	mm	595	610	610	615	615
L2	mm	590	1166	1166	1166	1166
L3	mm	198	88	88	88	88
W1		DN65 PN6	DN80 PN6	DN80 PN6	DN80 PN6	DN80 PN6
W2		DN65 PN6	DN80 PN6	DN80 PN6	DN80 PN6	DN80 PN6

As a result of manufacturing tolerances, there may be small variations in the dimensions. (Changes may be introduced without notice)

STOKVIS ENERGY SYSTEMS



STOKVIS ENERGY SYSTEMS

STOKVIS INDUSTRIAL BOILERS
 (INTERNATIONAL) LIMITED
 96R Walton Road East Molesey Surrey KT8 0DL
 TELEPHONE 0208 783 3050 • FACSIMILE 0208 783 3051
 Email: info@stokvisboilers.com • Website: <http://www.stokvisboilers.com>